

N-Channel Enhancement Mode Field Effect Transistor

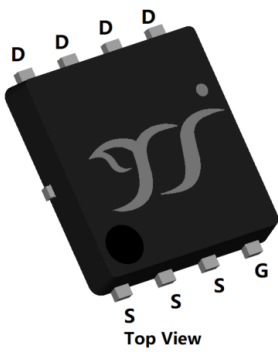

PDFN5060-8L

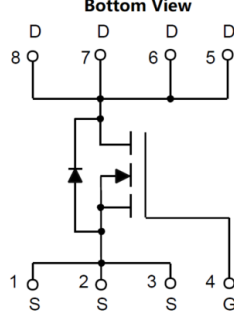
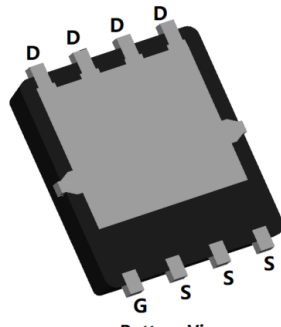

Product Summary

- V_{DS} 60V
- I_D 220A
- $R_{DS(ON)}$ (at $V_{GS}=10V$) $< 1.6m\Omega$
- $R_{DS(ON)}$ (at $V_{GS}=4.5V$) $< 2.4m\Omega$
- 100% EAS Tested
- 100% ∇V_{DS} Tested

General Description

- Split gate trench MOSFET technology
- Excellent package for heat dissipation
- High density cell design for low $R_{DS(ON)}$
- Moisture Sensitivity Level 3
- Epoxy Meets UL 94 V-0 Flammability Rating
- Halogen Free

Applications

- Power switching application
- Uninterruptible power supply
- DC-DC convertor

■ Absolute Maximum Ratings ($T_A=25^\circ C$ unless otherwise noted)

Parameter		Symbol	Limit	Unit
Drain-source Voltage		V_{DS}	60	V
Gate-source Voltage		V_{GS}	± 20	V
Drain Current	$T_A=25^\circ C$	I_D	27	A
	$T_A=100^\circ C$		17	
	$T_C=25^\circ C$		220	
	$T_C=100^\circ C$		139	
Pulsed Drain Current ^A		I_{DM}	800	A
Avalanche energy ^B		EAS	676	mJ
Total Power Dissipation ^C	$T_A=25^\circ C$	P_D	2.5	W
	$T_A=100^\circ C$		1	
	$T_C=25^\circ C$		147	
	$T_C=100^\circ C$		58	
Junction and Storage Temperature Range		T_J, T_{STG}	-55~+150	$^\circ C$

■ Thermal resistance

Parameter		Symbol	Typ	Max	Units
Thermal Resistance Junction-to-Ambient ^D	Steady-State	$R_{\theta JA}$	40	50	$^\circ C/W$
Thermal Resistance Junction-to-Case	Steady-State	$R_{\theta JC}$	0.7	0.85	

■ Ordering Information (Example)

PREFERRED P/N	PACKING CODE	Marking	MINIMUM PACKAGE(pcs)	INNER BOX QUANTITY(pcs)	OUTER CARTON QUANTITY(pcs)	DELIVERY MODE
YJG220G06AR	F1	G220G06AR	5000	10000	100000	13" reel

■ Electrical Characteristics ($T_J=25^\circ\text{C}$ unless otherwise noted)

Parameter	Symbol	Conditions	Min	Typ	Max	Units
Static Parameter						
Drain-Source Breakdown Voltage	BV_{DSS}	$V_{GS}=0V, I_D=250\mu A$	60	-	-	V
Zero Gate Voltage Drain Current	I_{DSS}	$V_{DS}=60V, V_{GS}=0V$	-	-	1	μA
		$V_{DS}=60V, V_{GS}=0V, T_J=150^\circ\text{C}$	-	-	100	
Gate-Body Leakage Current	I_{GSS}	$V_{GS}=\pm 20V, V_{DS}=0V$	-	-	± 100	nA
Gate Threshold Voltage	$V_{GS(th)}$	$V_{DS}=V_{GS}, I_D=250\mu A$	1	1.8	2.5	V
Static Drain-Source On-Resistance	$R_{DS(on)}$	$V_{GS}=10V, I_D=110A$	-	1.2	1.6	m Ω
		$V_{GS}=10V, I_D=50A$	-	1.2	1.6	
		$V_{GS}=4.5V, I_D=50A$	-	1.8	2.4	
Diode Forward Voltage	V_{SD}	$I_S=110A, V_{GS}=0V$	-	0.85	1.2	V
Gate resistance	R_G	$f=1\text{MHz}$	-	1.5	-	Ω
Maximum Body-Diode Continuous Current	I_S		-	-	220	A
Dynamic Parameters						
Input Capacitance	C_{iss}	$V_{DS}=30V, V_{GS}=0V, f=1\text{MHz}$	-	7500	-	pF
Output Capacitance	C_{oss}		-	1450	-	
Reverse Transfer Capacitance	C_{riss}		-	80	-	
Switching Parameters						
Total Gate Charge	Q_g	$V_{GS}=10V, V_{DS}=30V, I_D=110A$	-	119	-	nC
Gate-Source Charge	Q_{gs}		-	25	-	
Gate-Drain Charge	Q_{gd}		-	20	-	
Reverse Recovery Charge	Q_{rr}	$I_F=110A, di/dt=100A/\mu s$	-	143	-	nC
Reverse Recovery Time	t_{rr}		-	90	-	ns
Turn-on Delay Time	$t_{D(on)}$	$V_{GS}=10V, V_{DD}=30V, I_D=110A$ $R_{GEN}=2.2\Omega$	-	20	-	ns
Turn-on Rise Time	t_r		-	250	-	
Turn-off Delay Time	$t_{D(off)}$		-	50	-	
Turn-off fall Time	t_f		-	15	-	

A. Repetitive rating; pulse width limited by max. junction temperature.

B. $T_J=25^\circ\text{C}$, $V_{DD}=30V$, $V_G=10V$, $R_G=25\Omega$, $L=2\text{mH}$, $I_{AS}=26A$.

C. P_d is based on max. junction temperature, using junction-case thermal resistance.

D. The value of $R_{\theta JA}$ is measured with the device mounted on 1 in² FR-4 board with 2oz. Copper, in the still air environment with $T_A=25^\circ\text{C}$. The maximum allowed junction temperature of 150°C . The value in any given application depends on the user's specific board design.

Typical Electrical and Thermal Characteristics Diagrams

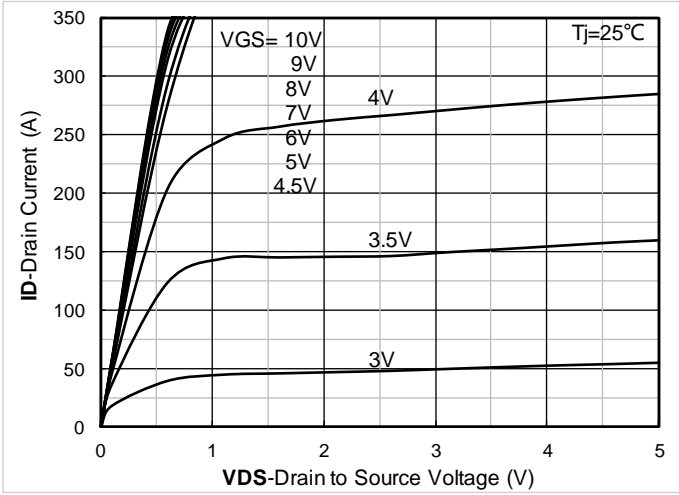

Figure 1. Output Characteristics

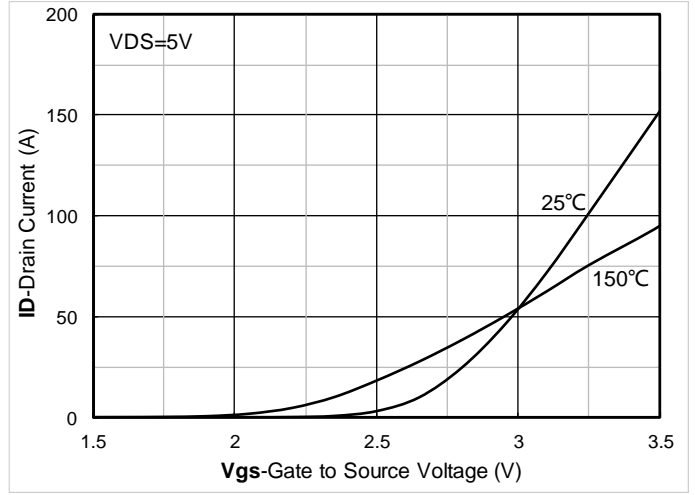

Figure 2. Transfer Characteristics

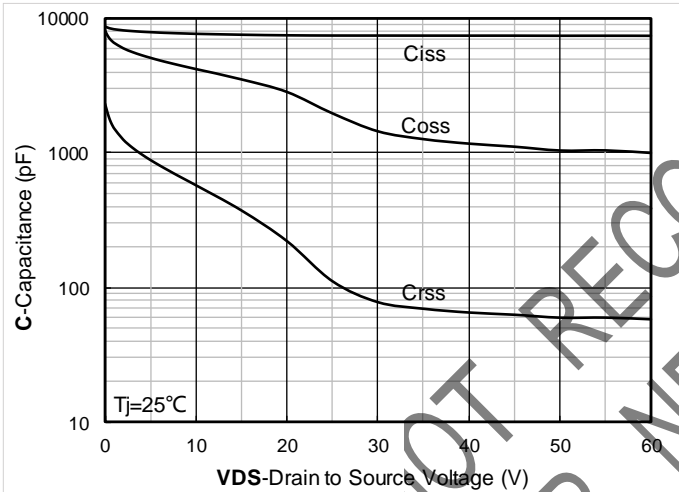

Figure 3. Capacitance Characteristics

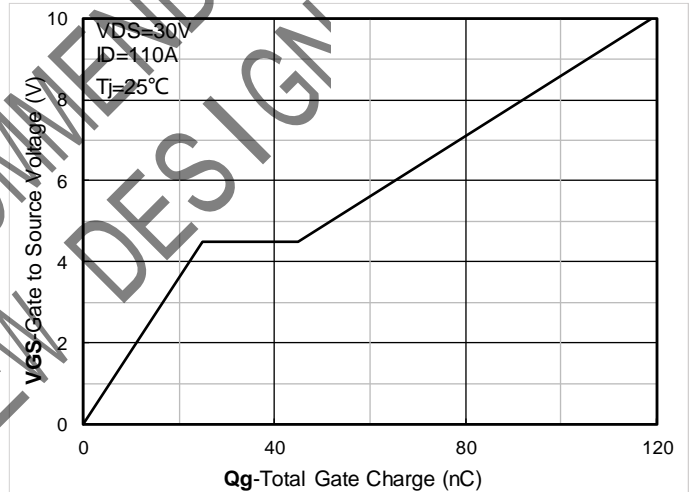

Figure 4. Gate Charge

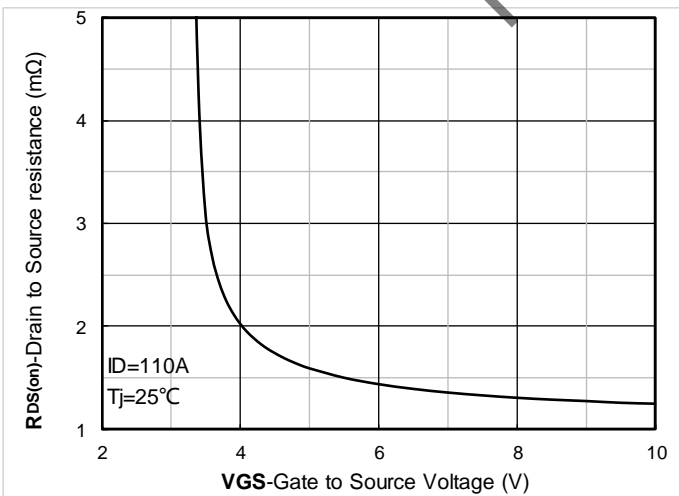

Figure 5. On-Resistance vs Gate to Source Voltage

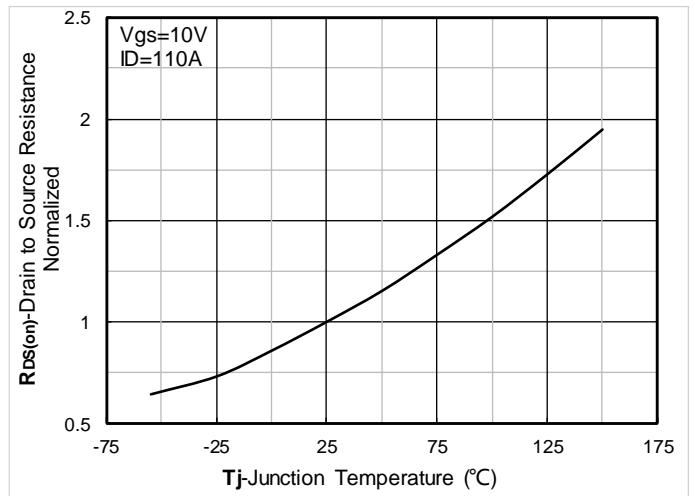

Figure 6. Normalized On-Resistance

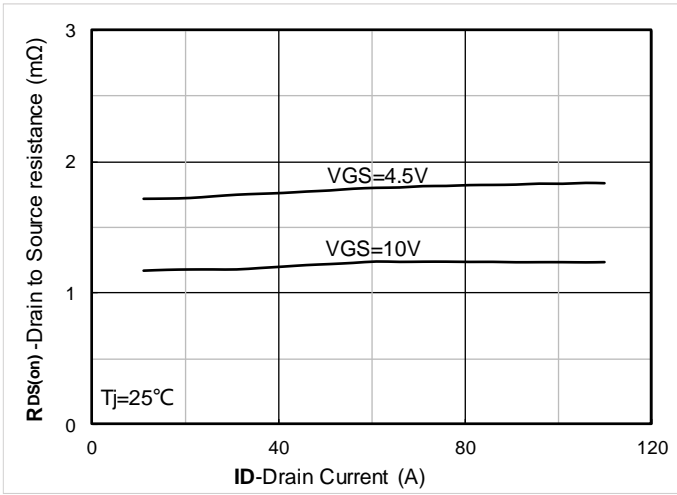

Figure 7. RDS(on) vs Drain Current

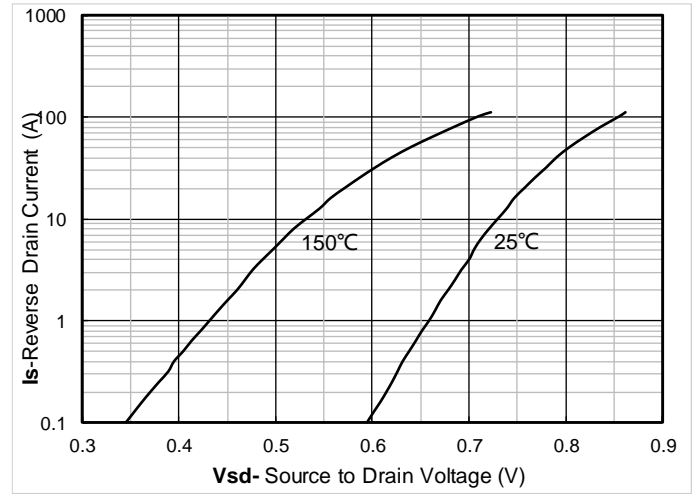

Figure 8. Forward characteristics of reverse diode

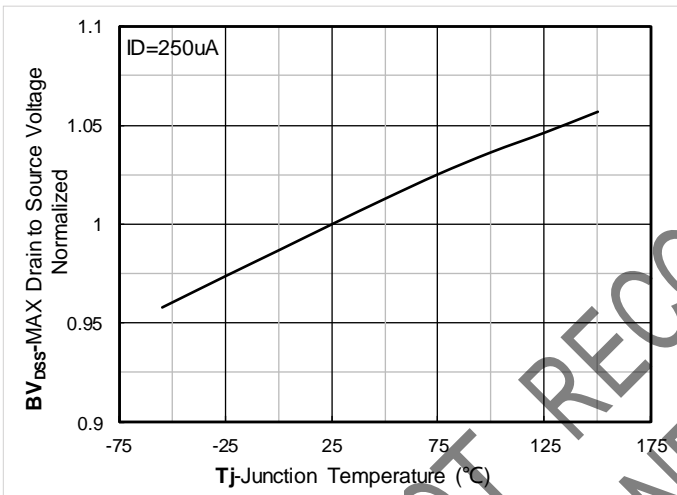

Figure 9. Normalized breakdown voltage

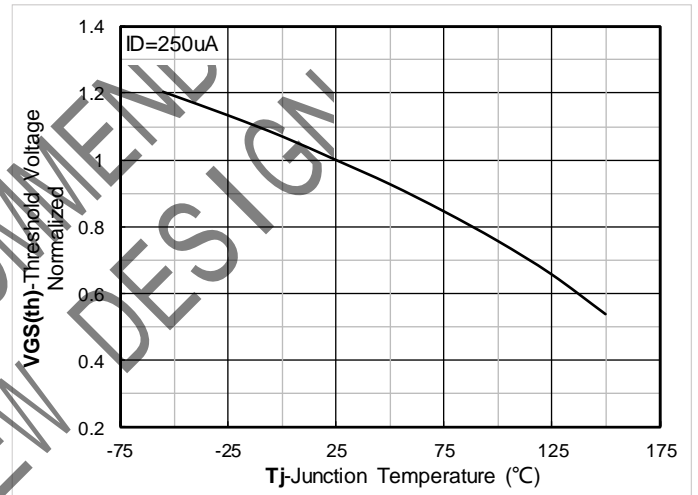

Figure 10. Normalized Threshold voltage

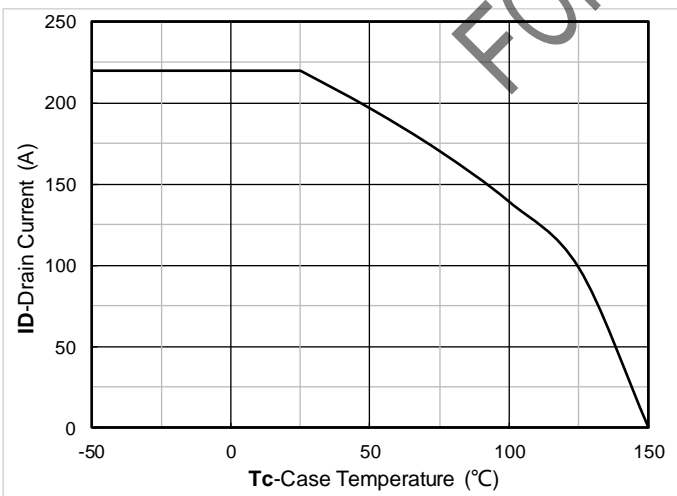

Figure 11. Current dissipation

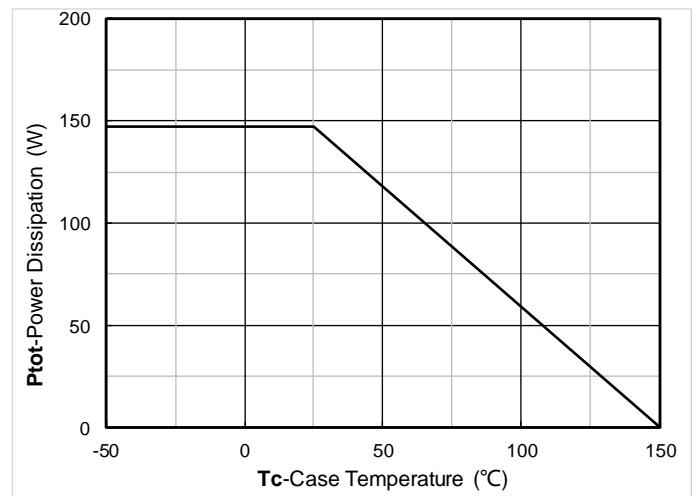

Figure 12. Power dissipation

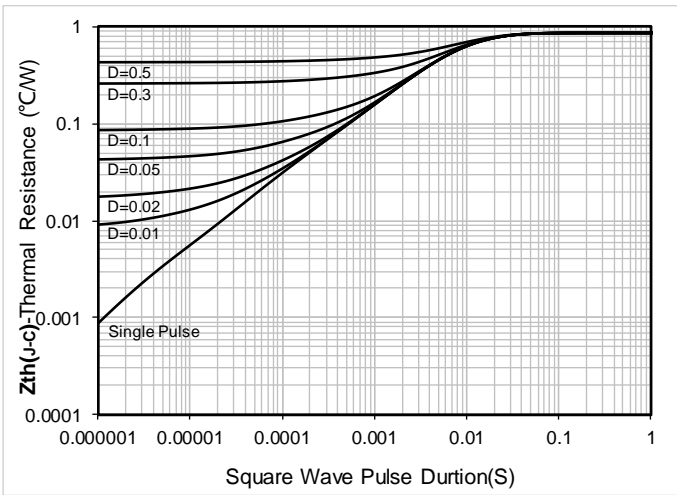

Figure 13. Maximum Transient Thermal Impedance

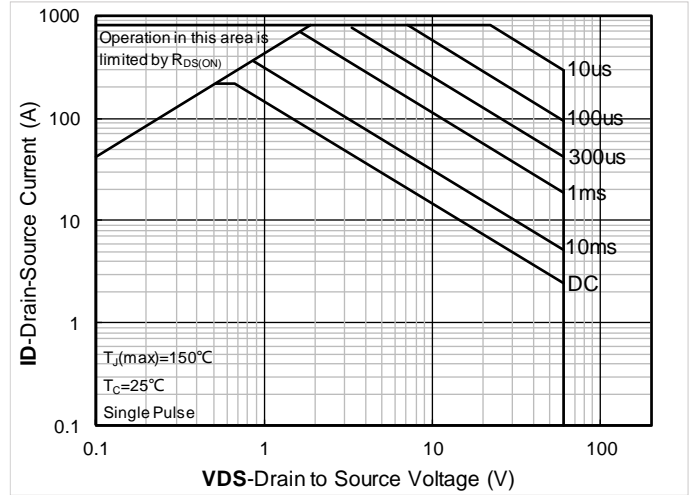

Figure 14. Safe Operation Area

■ Test Circuits & Waveforms

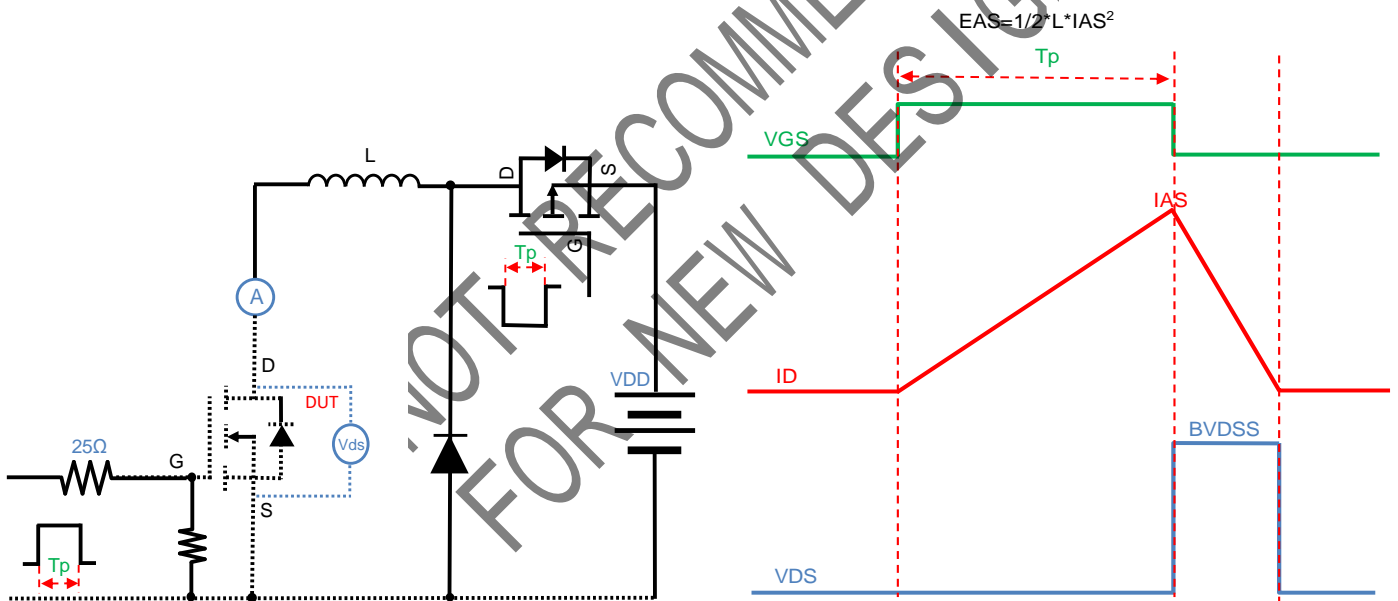

Figure A. Unclamped Inductive Switching (UIS) Test Circuit & Waveform

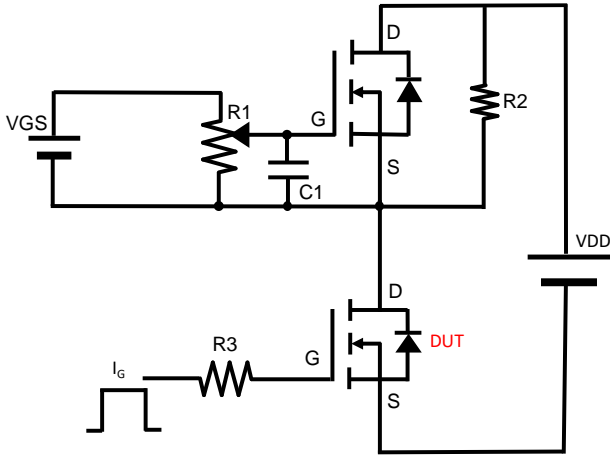

Figure B. Gate Charge Test Circuit & Waveform

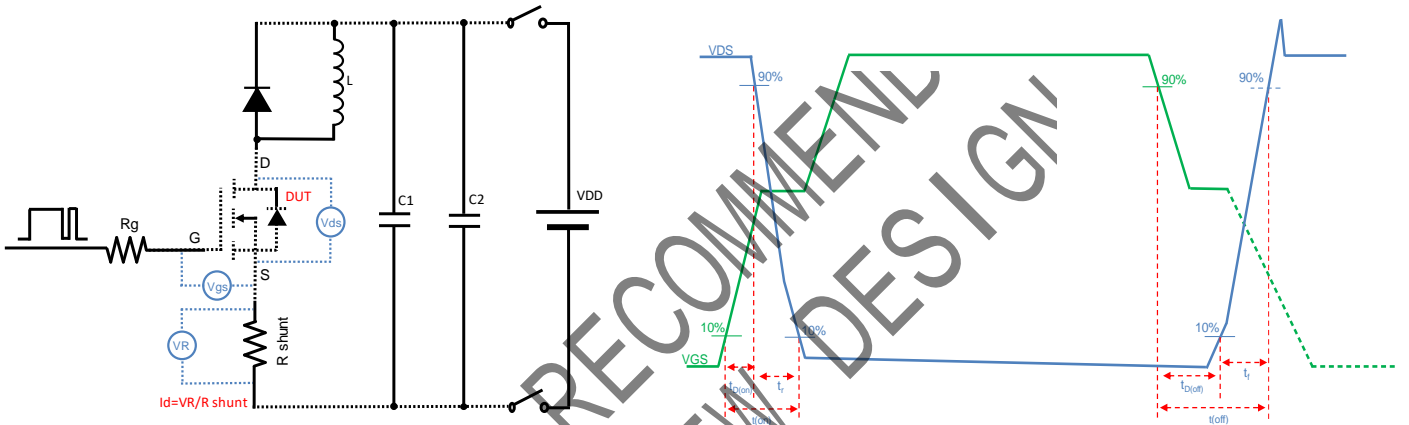

Figure C. Resistive Switching Test Circuit & Waveform

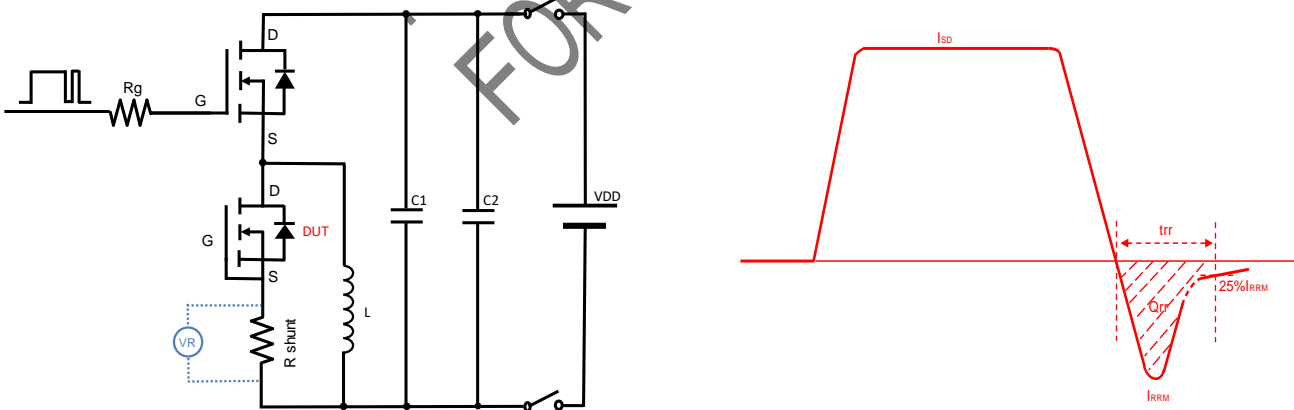
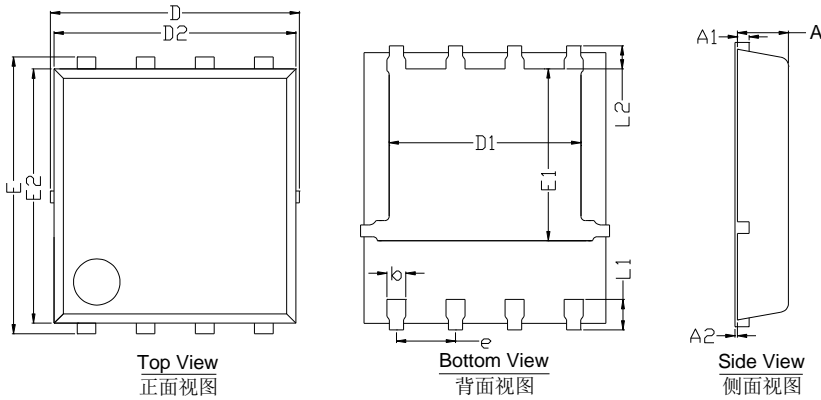

Figure D. Diode Recovery Test Circuit & Waveform

■ PDFN5060-8L-D-0.95MM Package information



SYMBOL	MILLIMETER		
	MIN	NOM	MAX
D	5.15	5.35	5.55
E	5.95	6.05	6.15
A	0.85	0.95	1.00
A1	0.203 BSC		
A2			0.08
D1	4.25	4.35	4.45
E1	3.525	3.625	3.725
D2		5.20	
E2		5.55	
L1	0.45	0.55	0.65
L2	0.68 BSC		
b	0.3	0.4	0.5
e	1.27 BSC		

Note:

1. Controlling dimension: in millimeters.
2. General tolerance: $\pm 0.10\text{mm}$.
3. The pad layout is for reference purposes only.

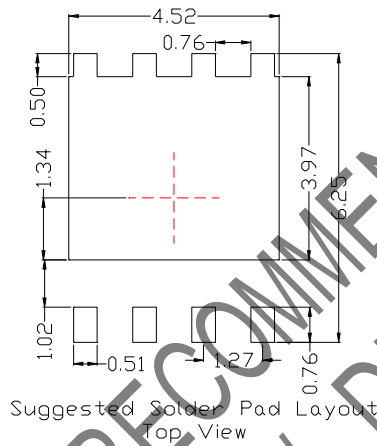

Suggested Solder Pad Layout
Top View

NOT RECOMMEND FOR NEW DESIGN



Disclaimer

The information presented in this document is for reference only. Yangzhou Yangjie Electronic Technology Co., Ltd. reserves the right to make changes without notice for the specification of the products displayed herein to improve reliability, function or design or otherwise.

The product listed herein is designed to be used with ordinary electronic equipment or devices, and not designed to be used with equipment or devices which require high level of reliability and the malfunction of which would directly endanger human life (such as medical instruments, transportation equipment, aerospace machinery, nuclear-reactor controllers, fuel controllers and other safety devices), Yangjie or anyone on its behalf, assumes no responsibility or liability for any damages resulting from such improper use of sale.

This publication supersedes & replaces all information previously supplied. For additional information, please visit our website <http://www.21yangjie.com> , or consult your nearest Yangjie's sales office for further assistance.

NOT RECOMMEND
FOR NEW DESIGN