

N-Channel Enhancement Mode Field Effect Transistor

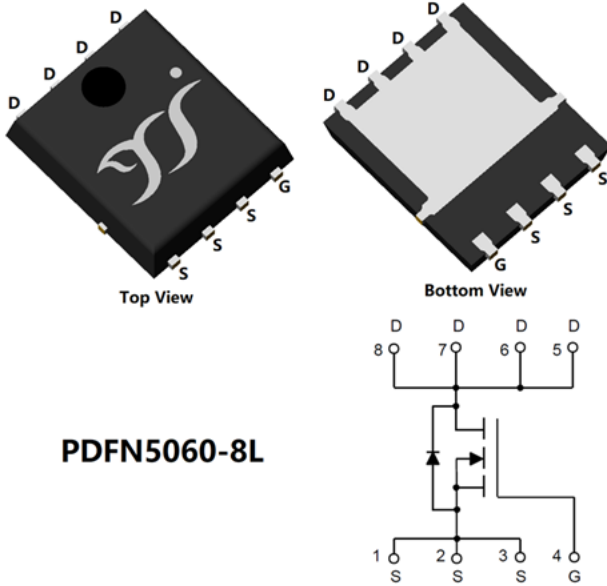

PDFN5060-8L

Product Summary

- V_{DS} 40V
- I_D 80A
- $R_{DS(ON)}$ (at $V_{GS}=10V$) $<4.4m\Omega$
- $R_{DS(ON)}$ (at $V_{GS}=4.5V$) $<8m\Omega$
- 100% EAS Tested
- 100% ∇V_{DS} Tested

General Description

- Excellent package for heat dissipation
- High density cell design for low $R_{DS(ON)}$
- Moisture Sensitivity Level 1
- Epoxy Meets UL 94 V-0 Flammability Rating
- Halogen Free

Applications

- Power switching application
- Uninterruptible power supply
- DC-DC convertor

Limiting Values

Parameter		Symbol	Min	Max	Unit	
Drain-source Voltage		V_{DS}	-	40	V	
Gate-source Voltage		V_{GS}	-20	20	V	
Continuous Drain Current (Note 1,2)	Steady-State	I_D	$T_A=25^\circ C, V_{GS}=10V$	-	18	A
			$T_A=100^\circ C, V_{GS}=10V$	-	12.7	
Continuous Drain Current (Note 1,3)	Steady-State	I_D	$T_C=25^\circ C, V_{GS}=10V, \text{Chip limitation}$	-	80	
			$T_C=100^\circ C, V_{GS}=10V$	-	56	
Pulsed Drain Current	$T_C=25^\circ C, t_p \leq 10\mu s$		I_{DM}	-	320	A
Avalanche energy (non-repetitive)		$V_G=10V, R_G=25\Omega, L=0.5mH, I_{AS}=15.5A$	EAS	-	60	mJ
Total Power Dissipation (Note 1,2)	Steady-State	P_D	$T_A=25^\circ C$	-	2.6	W
			$T_A=100^\circ C$	-	1.3	
Total Power Dissipation (Note 1,3)	Steady-State	P_D	$T_C=25^\circ C$	-	51	
			$T_C=100^\circ C$	-	25	
Junction and Storage Temperature Range		T_J, T_{STG}	-55	175	$^\circ C$	

Thermal resistance

Parameter		Symbol	Typ	Max	Units
Thermal Resistance Junction-to-Ambient (Note 2)	Steady-State	$R_{\theta JA}$	-	56	$^\circ C/W$
Thermal Resistance Junction-to-Case	Steady-State	$R_{\theta JC}$	-	2.9	

Ordering Information (Example)

PREFERRED P/N	PACKING CODE	Marking	MINIMUM PACKAGE(pcs)	INNER BOX QUANTITY(pcs)	OUTER CARTON QUANTITY(pcs)	DELIVERY MODE
YJG4D4G04A	F1	YJG4D4G04A	5000	10000	100000	13" reel



YJG4D4G04A

■ Electrical Characteristics (T_J=25°C unless otherwise noted)

Parameter	Symbol	Conditions	Min	Typ	Max	Units
Static Parameter						
Drain-Source Breakdown Voltage	BV _{DSS}	V _{GS} =0V, I _D =250μA	40	-	-	V
		V _{GS} =0V, I _D =10mA	40	-	-	V
Zero Gate Voltage Drain Current	I _{DSS}	V _{DS} =32V, V _{GS} =0V	-	-	1	μA
		V _{DS} =32V, V _{GS} =0V, T _J =125°C	-	-	100	
Gate-Body Leakage Current	I _{GSS}	V _{GS} =±20V, V _{DS} =0V	-	-	±100	nA
Gate Threshold Voltage	V _{GS(th)}	V _{DS} =V _{GS} , I _D =250μA	1.2	1.7	2.5	V
Static Drain-Source On-Resistance	R _{DS(on)}	V _{GS} =10V, I _D =40A	-	3.3	4.4	mΩ
		V _{GS} =4.5V, I _D =20A	-	5.8	8	mΩ
Diode Forward Voltage	V _{SD}	I _S =40A, V _{GS} =0V	-	0.85	1.2	V
Gate resistance	R _G	f=1MHz	-	1.4	-	Ω
Maximum Body-Diode Continuous Current	I _S		-	-	50	A
Dynamic Parameters						
Input Capacitance	C _{iss}	V _{DS} =20V, V _{GS} =0V, f=1MHz	-	970	-	pF
Output Capacitance	C _{oss}		-	540	-	
Reverse Transfer Capacitance	C _{rss}		-	23	-	
Switching Parameters						
Total Gate Charge	Q _g	V _{GS} =10V, V _{DS} =20V, I _D =50A	-	16.4	-	nC
Gate-Source Charge	Q _{gs}		-	3.3	-	
Gate-Drain Charge	Q _{gd}		-	5	-	
Reverse Recovery Charge	Q _{rr}	I _F =50A, di/dt=100A/us, V _{GS} =0V, V _R =20V	-	7	-	nC
Reverse Recovery Time	t _{rr}		-	19.5	-	ns
Turn-on Delay Time	t _{D(on)}	V _{GS} =10V, V _{DS} =20V, I _D =50A, R _L =0.4Ω R _{GEN} =3Ω	-	8.4	-	ns
Turn-on Rise Time	t _r		-	11.9	-	
Turn-off Delay Time	t _{D(off)}		-	18.7	-	
Turn-off fall Time	t _f		-	5.8	-	

Note:

- The entire application environment impacts the thermal resistance values shown, they are not constants and are only valid for the particular conditions noted.
- The value of R_{θJA} is measured with the device mounted on the 40mm*40mm*1.1mm single layer FR-4 PCB board with 1 in² pad of 2oz. Copper, in the still air environment with TA =25°C. The maximum allowed junction temperature of 175°C. The value in any given application depends on the user's specific board design.
- Thermal resistance from junction to soldering point (on the exposed drain pad).



YJG4D4G04A

Typical Electrical and Thermal Characteristics Diagrams

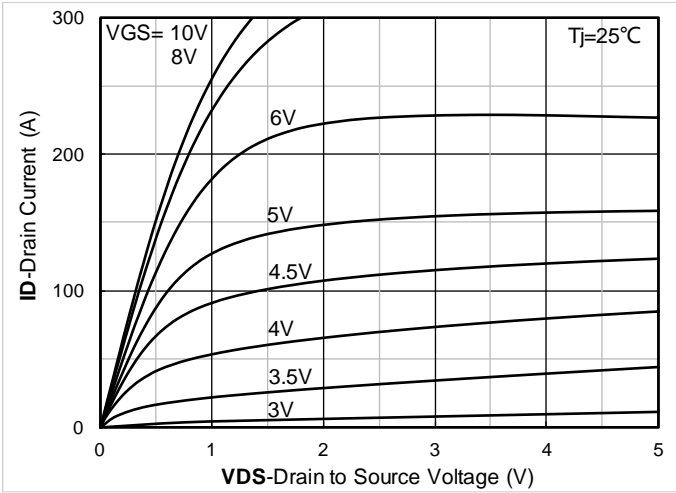

Figure 1. Output Characteristics

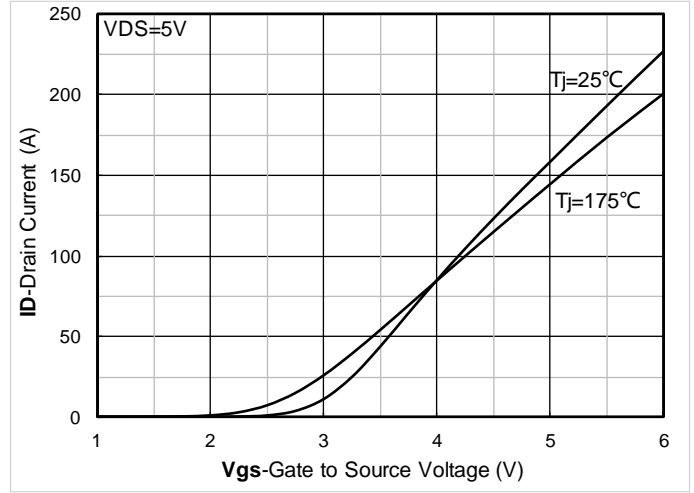

Figure 2. Transfer Characteristics

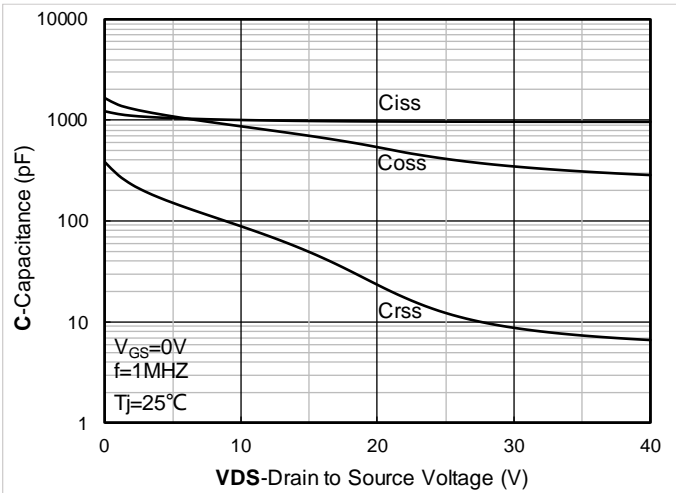

Figure 3. Capacitance Characteristics

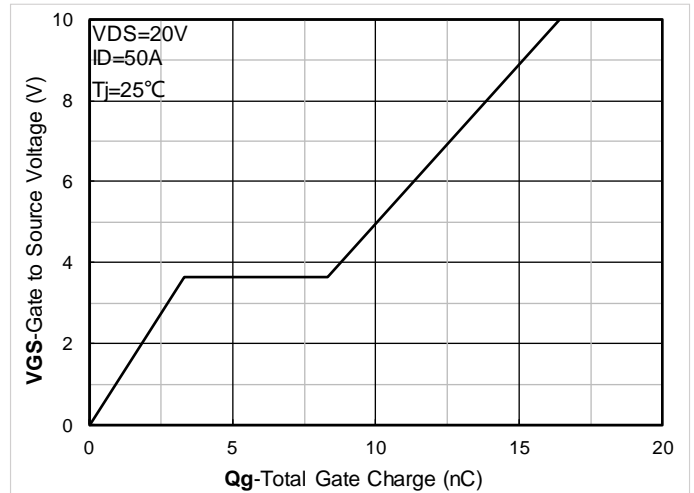

Figure 4. Gate Charge

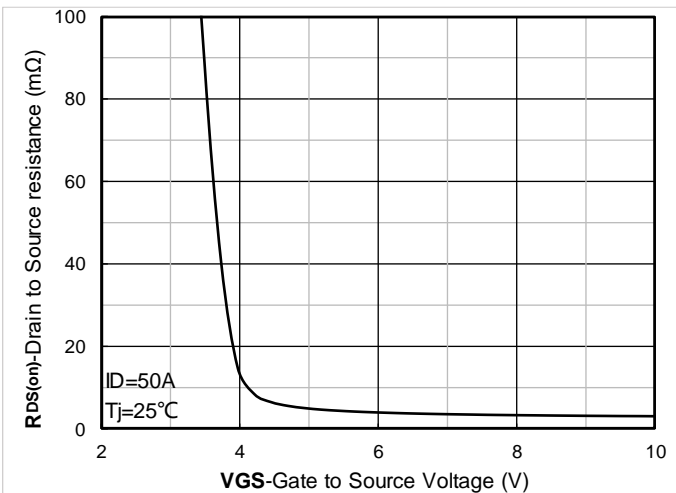

Figure 5. On-Resistance vs Gate to Source Voltage

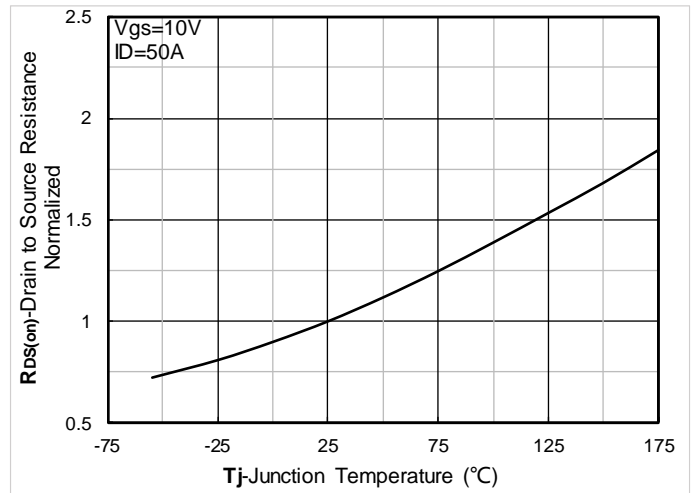

Figure 6. Normalized On-Resistance



YJG4D4G04A

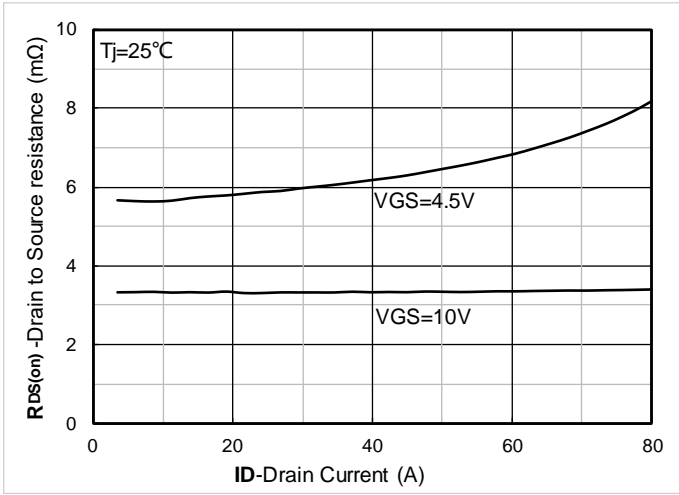

Figure 7. $R_{DS(on)}$ VS Drain Current

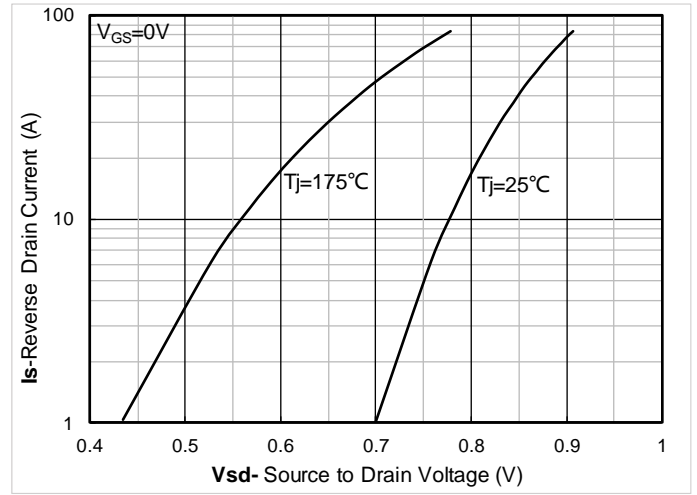

Figure 8. Forward characteristics of reverse diode

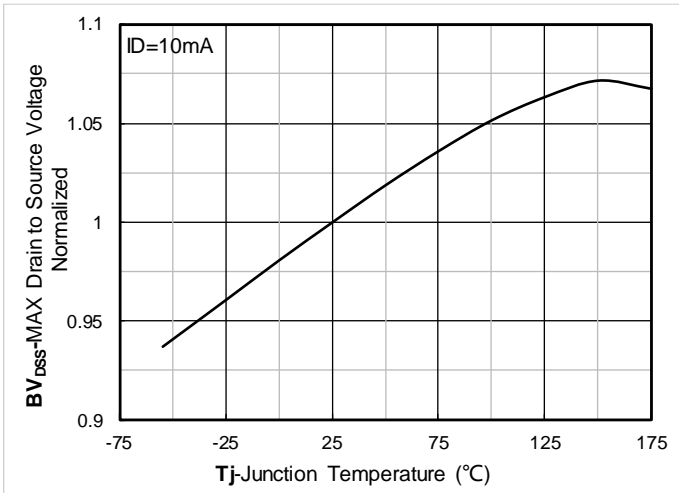

Figure 9. Normalized breakdown voltage

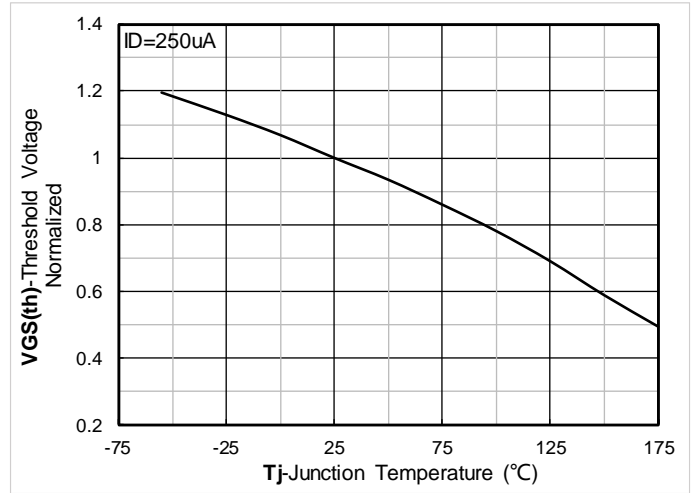

Figure 10. Normalized Threshold voltage

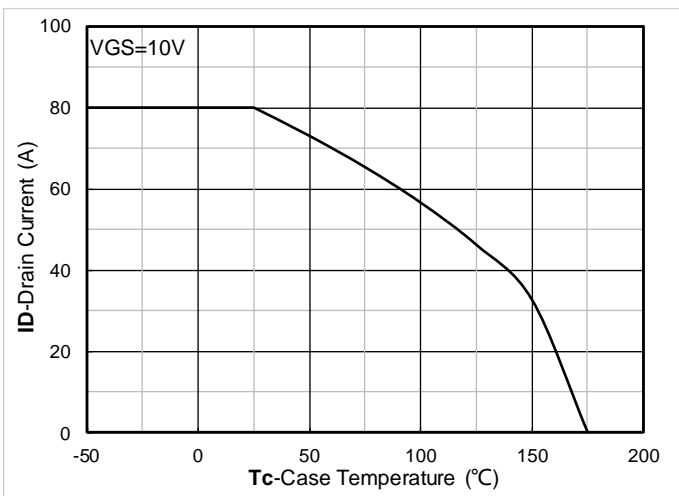

Figure 11. Current dissipation

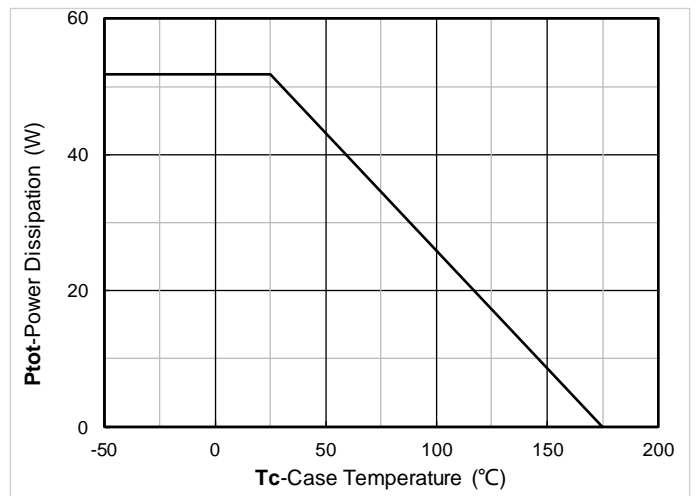

Figure 12. Power dissipation

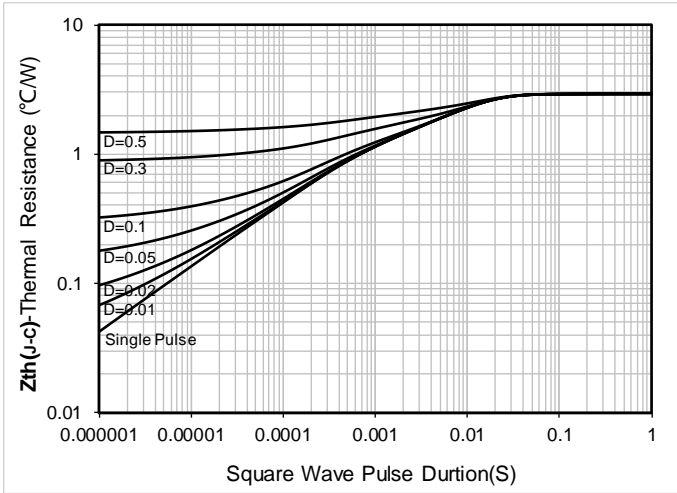

Figure 13. Maximum Transient Thermal Impedance

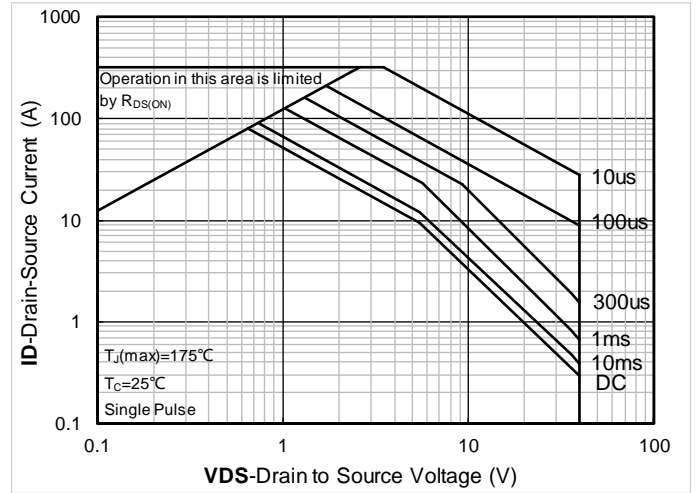

Figure 14. Safe Operation Area

■ Test Circuits & Waveforms

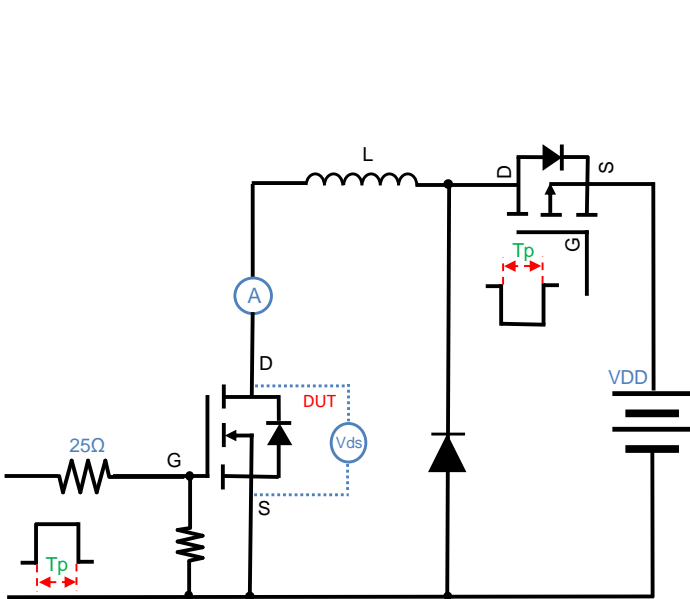
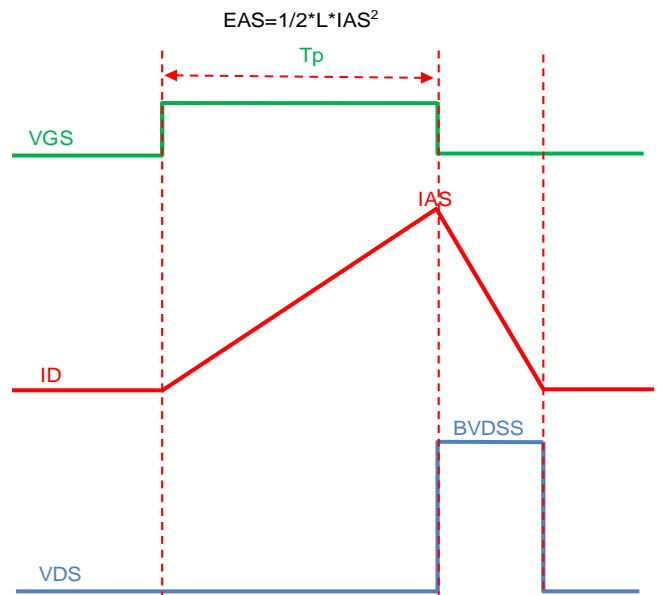

Figure A. Unclamped Inductive Switching (UIS) Test Circuit & Waveform



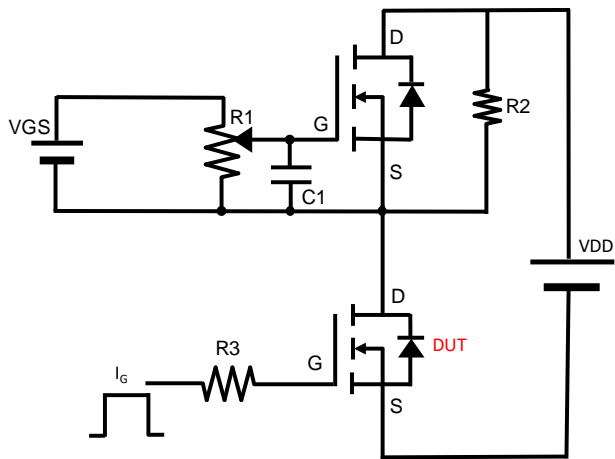

Figure B. Gate Charge Test Circuit & Waveform



Figure C. Resistive Switching Test Circuit & Waveform

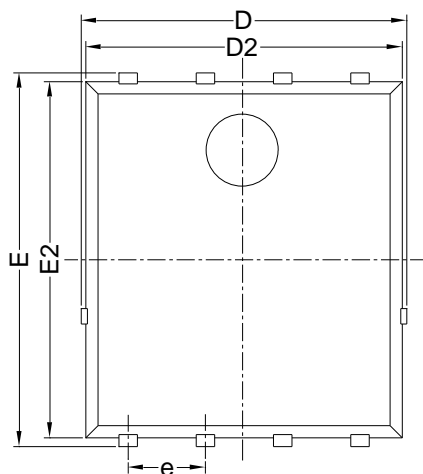

Figure D. Diode Recovery Test Circuit & Waveform



YJG4D4G04A

■ PDFN5060-8L-B-1.1mm Package information



Top View
正面视图

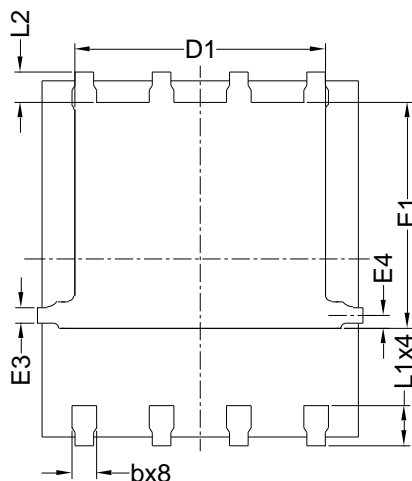

Bottom View
背面视图

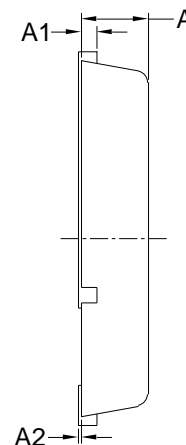

Side View
侧面视图

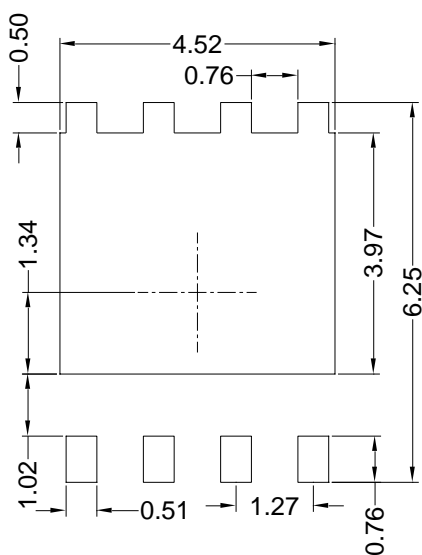

Suggested Solder Pad Layout
Top View

SYMBOL	MILLIMETER		
	MIN	NOM	MAX
D	5.15	5.35	5.55
E	5.95	6.15	6.35
A	1.00	1.10	1.20
A1	0.254 BSC		
A2			0.10
D1	3.92	4.12	4.32
E1	3.52	3.72	3.92
D2	5.00	5.20	5.40
E2	5.66	5.86	6.06
E3	0.254 REF		
E4	0.21 REF		
L1	0.56	0.66	0.76
L2	0.50 BSC		
b	0.31	0.41	0.51
e	1.27 BSC		

Note:

1. Controlling dimension: in millimeters.
2. General tolerance: ± 0.10 mm.
3. The pad layout is for reference purposes only.



YJG4D4G04A

Disclaimer

The information presented in this document is for reference only. Yangzhou Yangjie Electronic Technology Co., Ltd. reserves the right to make changes without notice for the specification of the products displayed herein to improve reliability, function or design or otherwise.

The product listed herein is designed to be used with ordinary electronic equipment or devices, and not designed to be used with equipment or devices which require high level of reliability and the malfunction of which would directly endanger human life (such as medical instruments, transportation equipment, aerospace machinery, nuclear-reactor controllers, fuel controllers and other safety devices), Yangjie or anyone on its behalf, assumes no responsibility or liability for any damages resulting from such improper use of sale.

This publication supersedes & replaces all information previously supplied. For additional information, please visit our website <http://www.21yangjie.com> , or consult your nearest Yangjie's sales office for further assistance.